

SeaShield Marine Systems

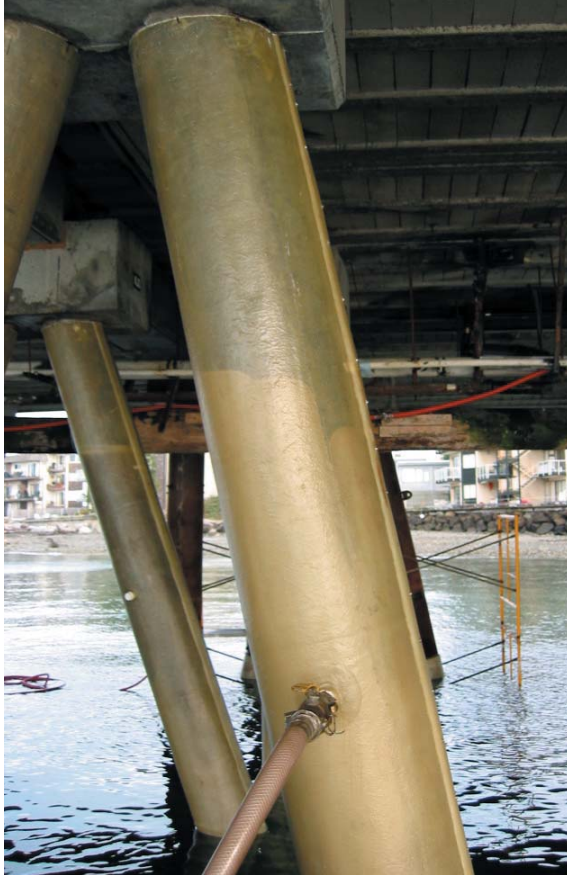

SeaShield 550 Epoxy Grout being pumped into the SeaShield Series 500 Fiber-Form Jacket.

Series 500

Heavy-duty pile protection system with a fiber-glass jacket and SeaShield 550 Epoxy Grout

SeaShield Series 500 System is comprised of the SeaShield Fiber-Form Jacket and SeaShield 550 Epoxy Grout. The system can be applied above and/or below the water with inexpensive pumping equipment or poured into the pile jacket. The Series 500 System is tough, durable and provides the ultimate protection to restore steel, concrete and timber piles.

Features

- Outstanding abrasion resistance
- Easy to install
- Non-corrosive
- Requires inexpensive pumping equipment
- Flowable epoxy grout
- Excellent adhesion to substrate
- Manufactured to be translucent with clear gel coat
- High impact resistance
- UV resistant
- Long maintenance-free service life

— premier —
COATINGS LTD

Materials

The SeaShield Series 500 System is comprised of a Fiber-Form Jacket which is a high quality formulation Fiberglass Reinforced Plastic (FRP) and SeaShield 550 Epoxy Grout. The product is designed specifically for protection of concrete, timber, and steel piles and provides an attractive, durable, and permanent system. Standard jackets are fabricated in thicknesses of 1/8" and 3/16".

The Fiber-Form Jacket is provided with a vertical closure. Noncorrosive standoffs (grout spacers) can be used inside the jacket to maintain proper spacing around the piling when pumping or pouring the SeaShield 550 Epoxy Grout.



The SeaShield 550 Epoxy Grout is a 3-component water displacing epoxy resin/aggregate formulation which provides a durable, well bonded repair to concrete, steel and timber piles below water. The 550 Epoxy Grout can be easily pumped into the Fiber-Form Jacket due to its excellent flowability characteristics.



SeaShield 550 Epoxy grout being mixed and poured into pump.

For further details please refer to the technical data sheets for the SeaShield Fiber-Form Jacket and SeaShield 550 Epoxy Grout.



SeaShield 550 Epoxy grout pumped into the annulus around an existing octagonal concrete pile.

Application

1. Thoroughly clean the existing pile by waterblasting, sandblasting or other acceptable methods. The SeaShield Series 500 Jacket can be installed at the tidal zone area or positioned below the mudline.
2. If a mudline repair is required, excavate the mud at the base of the pile and install the jacket. If tidal zone repair is required, install a work platform at the proper height using friction clamps secured to the pile.
3. Prepare the jacket with the required stand offs prior to using the SeaShield 550 Epoxy Grout.
4. Position the jacket around the pile and secure with a select strapping system every 18 inches or as required.
5. Prepare bottom seal with SeaShield 550 Epoxy Grout and allow to set. Pumping shall not commence until bottom seal is fully cured.
6. Fill jacket with SeaShield 550 Epoxy Grout at a constant slow rate of placement within allowable pressure ratings.

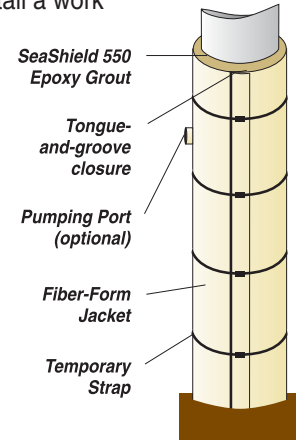

Find Out More

Contact Premier Coatings Ltd. for a complete literature package or a no-cost on-site evaluation of your application:

1-888-821-2300



HOUSTON:
9747 Whithorn Drive,
Houston, Texas,
U.S.A. 77095
Tel: 1-281-821-3355
Fax: 1-281-821-0304

TORONTO:
90 Ironside Crescent,
Unit 12, Toronto,
Ontario, Canada M1X1M3
Tel: 1-416-291-3435
Fax: 1-416-291-0898

e-mail: info@premiercoatings.com

www.premiercoatings.com

A Member of Winn & Coales International



Engineering Specifications for **SeaShield Series 500** Steel, Concrete and Timber Pile Protection

1.0 Scope

- 1.1 This specification may be used for the materials and application of SeaShield Series 500 Pile Encapsulation System.
- 1.2 The engineer shall select appropriate sections of the specifications to ensure that the specification is comprehensive for specified work.

2.0 General Requirements

- 2.1 Contractor shall comply with all written recommendations of the manufacturer regarding application of the specified system.
- 2.2 The manufacturer of specified materials shall be Premier Coatings Ltd., 9747 Whithorn Drive, Houston, TX 77095, Tel: 281-821-3355 or 90 Ironside Crescent, Unit 12, Toronto, Ontario, Canada M1X1M3 Tel: 416-291-3435. E-mail: info@premiercoatings.com

3.0 Materials

- 3.1 Fiberglass Jacket (SeaShield Fiber-Form)
 - 3.1.1 The fiberglass jacket thickness shall be 1/8" (3 mm) or 3/16" (4.8 mm) thickness, depending on the application and diameter size.
 - 3.1.2 The jacket shall be translucent to provide visual inspection during the injection of the epoxy grout.
 - 3.1.3 The jacket shall have minimum 1-1/4" (31.75 mm) injection ports spaced at intervals not to exceed five feet. To provide even distribution of the epoxy grout, the injection ports shall be placed on alternate sides (can be field installed by contractor).
 - 3.1.4 The jackets shall have stand-offs adhered to the inside of the jacket to provide a minimum of a 3/8" (8 mm) annulus (or per project spec) between the pile and the jacket (can be field installed by contractor). A UV inhibitor shall be included in the polyester resin to provide long-term UV stability.
 - 3.1.5 The fiberglass jackets shall have the following properties:

| | | |
|---------------------------|-----------|------------|
| Ultimate Tensile Strength | ASTM D638 | 16,000 PSI |
|---------------------------|-----------|------------|

| | | |
|----------------------|------------|----------------|
| IZOD Impact Strength | ASTM D256 | 20 ft.-lbf/in. |
| Barcol Hardness | ASTM D2583 | 40 |
| Water Absorption | ASTM D570 | 1% Max |
| UV Stability | ASTM G23 | 500 Hr. Pass |

3.1.6 The fiberglass jacket may be manufactured as either a single unit or as two pieces that shall be joined in the field. The jackets can be placed one above the other with the overlapping jacket having a molded open cavity to receive a bottom seal gasket.

3.2 Epoxy Grout

3.2.1 The epoxy grout shall be SeaShield 550 Epoxy Grout as manufactured by Premier Coatings Ltd. The grout shall exhibit the following properties:

Physical Properties (unmixed) @ 77°F (25°C)

| | |
|----------------------------|---------|
| Component "A" (resin): | |
| Specific Gravity | 1.13 |
| Viscosity | 600 cps |
| Component "B" (hardener): | |
| Specific Gravity | .96 |
| Viscosity | 100 cps |
| Component "C" (aggregate): | |
| Specific Gravity | 2.6 |
| Free flowing powder | |

Physical Properties (mixed) @ 77°F (25°C) with 3.5 parts Aggregate I to 1 part mixed "A" & "B"

| | |
|------------------|------|
| Specific Gravity | 1.88 |
| Solids by Weight | 100% |

Physical Properties (mixed) @ 77°F with 5 parts Aggregate I to 1 part mixed "A" & "B"

| | |
|------------------|------|
| Specific Gravity | 2.05 |
| Solids by Weight | 100% |

The grout shall be pre-mixed prior to pumping. The 3.5:1 or 5:1 mixing ratio shall provide a free flowing grout which can be pumped without segregation and voids between the pile and jacket.

The pot life of the mixed grout is approx. 100 minutes at 77°F (25°C) and should not be pumped beyond this time frame. The pot life will be considerably less as the temperature increases.

3.2.2 The cured epoxy grout shall exhibit the following physical properties:

| | | |
|----------------------------|-----------|------------------------|
| 7 Day Compressive Strength | ASTM C579 | 10,500 PSI (723.9 MPa) |
| 7 Day Tensile Strength | ASTM C307 | 2,200 PSI (15.17 MPa) |
| 7 Day Bond/Shear Strength | ASTM C882 | 2,000 PSI (13.79 MPa) |
| Shrinkage After 7 Day Cure | ASTM C531 | 0.07% |
| Water Absorp. After 7 Day | ASTM C413 | 0.45% Max. |

3.3 Adhesive Epoxy

3.3.1 The SeaShield Adhesive Epoxy shall be used to adhere the fiberglass vertical seams.

4.0 Equipment

4.1 The epoxy grout shall be pre-mixed and pumped through a peristaltic pump or rotor stator pump. The equipment shall be capable of delivering mixed grout through hoses into the jackets at a rate 1 GPM or greater. Contact equipment manufacture to make sure pump is capable of pumping epoxy grout.

4.2 Prior to using the pump, all lines shall be primed by circulating 1 gallon (3.8 liters) of the SeaShield Hose Lubricant.

4.3 The maximum hose length should be no longer than 50' (15 m).

5.0 Material Handling and Storage

5.1 Epoxy Grout Components

5.1.1 All liquid epoxy components shall be clearly marked with product name, component designation ("A" or "B"), manufactures name, batch number and ratio of component mixtures.

5.1.2 Epoxy components shall be stored in a covered, well ventilated space. The storage temperature shall not be less than 40°F (5°C) and no more than 120°F (49°C). It is recommended to store all components at 68°F to 86°F (20°C to 30°C) for 24 hours prior to use.

5.2 Fiberglass jackets on jobsite shall be stored in an area to prevent contamination and minimize distortion.

6.0 Surface Preparation

6.1 Prior to application, thoroughly clean and remove marine growth, oil, grease, rust and any other deleterious material which might prevent proper bonding between the pile and epoxy grout. Surface preparation shall be accomplished by grit blasting, power rotary tools or water blasting to provide a surface profile necessary to meet the bond requirements.

7.0 Installation

7.1 Preparation of Fiberglass Jacket

7.1.1 The inside surface of the jacket shall have a roughened / textured surface.

7.1.2 All stand-offs shall be affixed to the jacket at 18" (450 mm) to 48" (1200 mm) intervals (depending on diameter size, length and thickness of jacket in the field) along entire length of jacket. If additional stand-offs are required in the field, SeaShield Stand-off Adhesive can be used to adhere them.

7.1.3 All longitudinal and transverse seams shall be sealed with SeaShield Adhesive Epoxy as described in Section 3.3.1 and fastened with 3/16" (4.8 mm) diameter stainless steel rivets or screws that shall not exceed 6" (150 mm) spacing.

7.1.4 The jacket shall be supported by temporary nylon straps or other means to assure that it will not move or distort during placement of epoxy grout.

7.1.5 A bottom seal shall be fitted on each jacket to prevent any epoxy grout from leaching out of the bottom of the jacket during the placement.

7.2 Epoxy Grout Placement

7.2.1 All three components shall be mixed thoroughly and shall be pumped through a minimum 1-1/4" hose ID with a suitable pump such as a peristaltic or rotor stator pump.

7.2.2 A bottom plug of 6" (150 mm)– 12" (300 mm) of epoxy grout shall first be pumped into the lowest injection port. The epoxy grout shall be allowed to cure before proceeding with subsequent lifts.

7.2.3 Once epoxy grout is cured the grout injection shall begin at the bottom injection port and proceed upwards. As the jacket is filled to each port, the lower port shall be capped off and repeated until the top of the jacket is reached. The injection process shall be continuous except when the injection hose is moved from port to port.

7.3 Completion

7.3.1 After the injection process is completed and the epoxy grout has cured, all temporary supports shall be removed.

7.3.2 The top of each fiberglass jacket may be finished with the SeaShield 525 Epoxy.



HOUSTON:
9747 Whithorn Drive,
Houston, Texas,
U.S.A. 77095
Tel: 1-281-821-3355
Fax: 1-281-821-0304

TORONTO:
90 Ironside Crescent,
Unit 12, Toronto,
Ontario, Canada M1X1M3
Tel: 1-416-291-3435
Fax: 1-416-291-0898

e-mail: info@premiercoatings.com
www.premiercoatings.com

A Member of Winn & Coales International

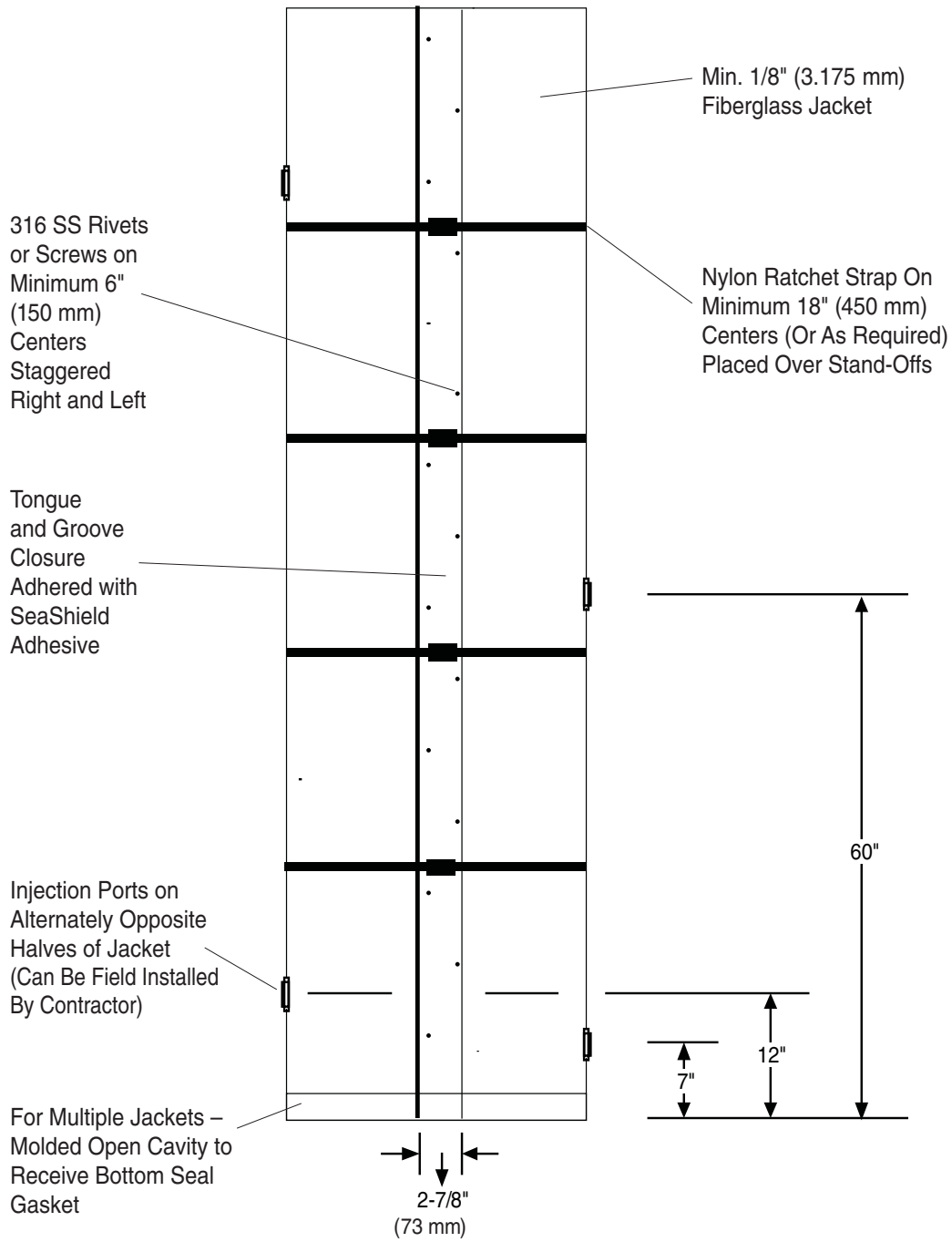

Elevation View

Note: All measurements are approximate and may vary due to diameter and length of jacket.

Sheet 1
(Not to Scale)

**SeaShield Series 500
Pile Encapsulation**



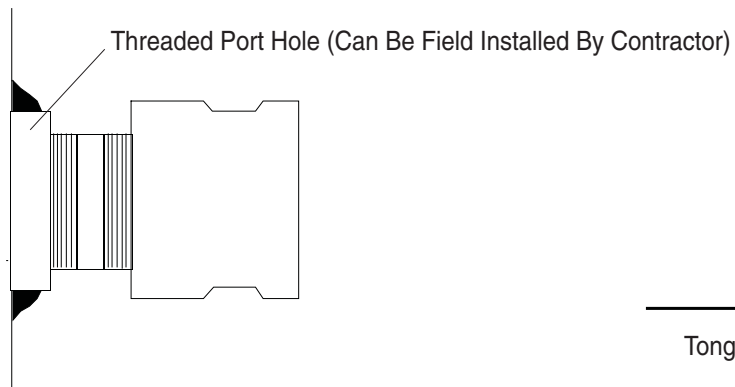

Injection Port Detail



Joint Option Details

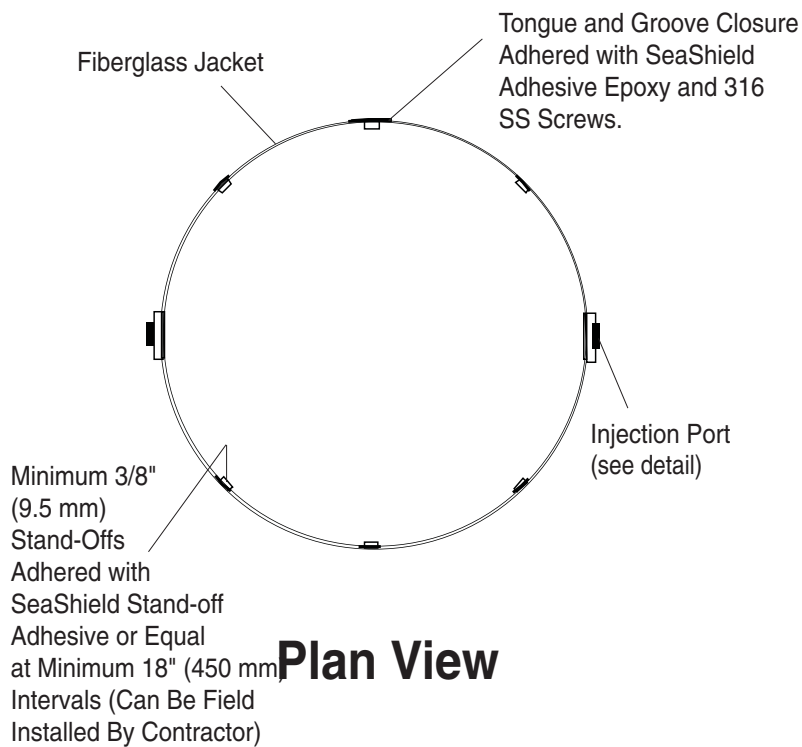

Sheet 2
(Not to Scale)

**SeaShield Series 500
Pile Encapsulation**





Step 1

Position SeaShield Fiber-Form Jacket around pile and seal longitudinal seams.



Step 2

Affix bottom seal gasket with select strapping.



Step 3

Connect grout hose to lower injection port and pump SeaShield 550 Epoxy Grout. Visually check for leaks. Plug upper port(s) and pump grout until it reaches top of jacket. (Upper ports are used only if pumping from lower ports becomes difficult.)



Step 4

(Alternate Pumping Method)

Contractor may choose to inject approximately 6" (150 mm) of SeaShield 550 Epoxy Grout and let cure before moving grout hose to next higher port and pumping remainder of grout. Pumping would then continue until grout reaches top of jacket.

Cured SeaShield 550 Epoxy Grout

Sheet 3

(Not to Scale)

SeaShield Series 500 Grout Placement Sequence



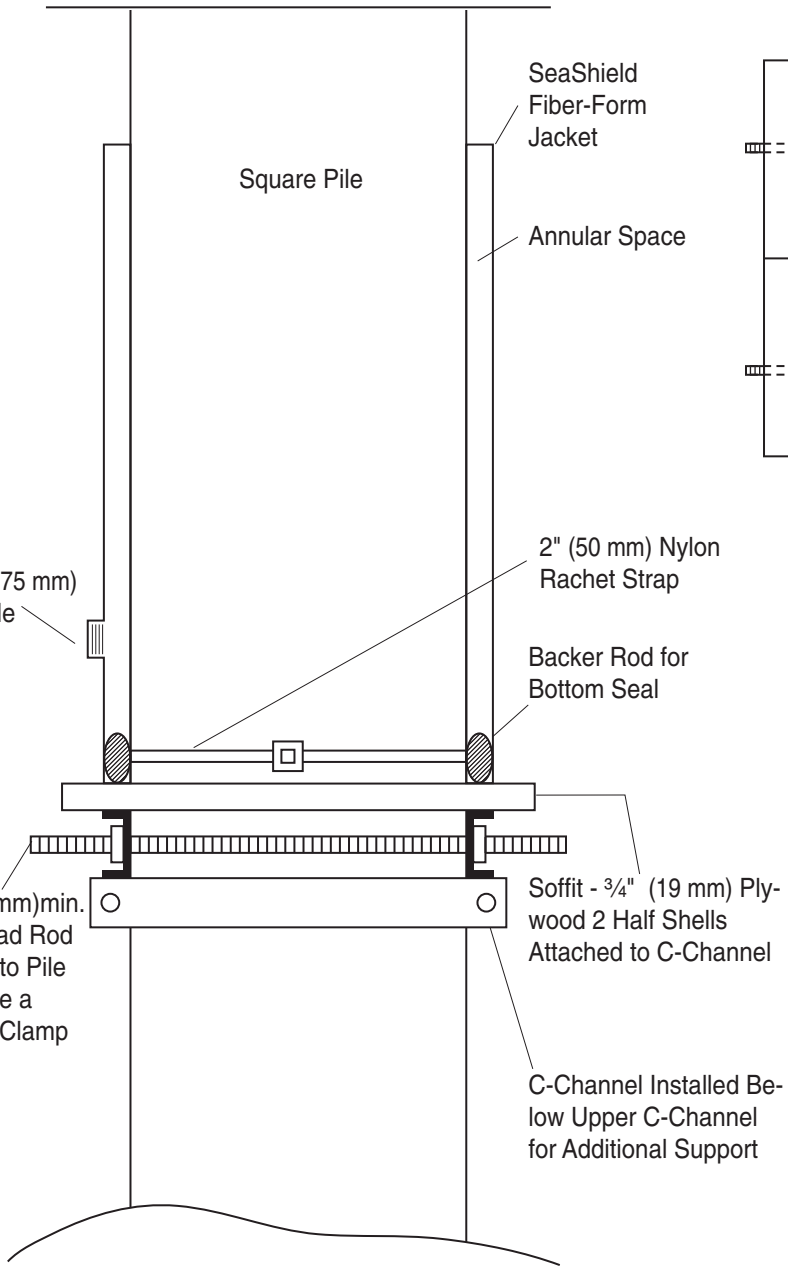

Elevation View

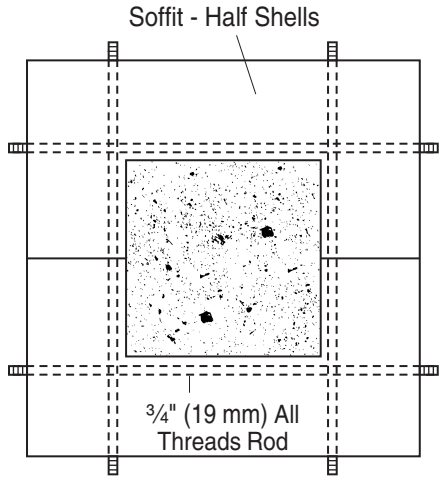

Plan View

Note: All measurements are approximate and may vary due to diameter and length of jacket.

Sheet 4
(Not to Scale)

**SeaShield Series 500
Soffit Detail**

